

122NQ030/R-1 SCHOTTKY RECTIFIER

Applications:

- Switching power supply
- Converters
- Free-Wheeling diodes
- Reverse battery protection

Features:

- 150°C T_J operation
- Unique high power, Half-Pak module
- Replaces three parallel DO-5'S
- Easier to mount and lower profile than DO-5'S
- High purity, high temperature epoxy encapsulation for enhanced mechanical strength and moisture resistance
- Low forward voltage drop
- High frequency operation
- Guard ring for enhanced ruggedness and long term reliability
- This is a Pb – Free Device
- All SMC parts are traceable to the wafer lot
- Additional testing can be offered upon request

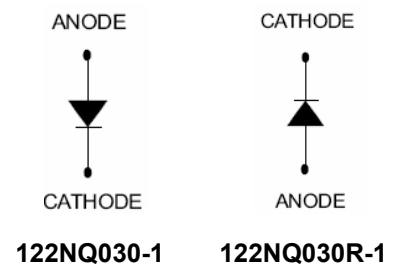

Mechanical Dimensions: In mm/Inches

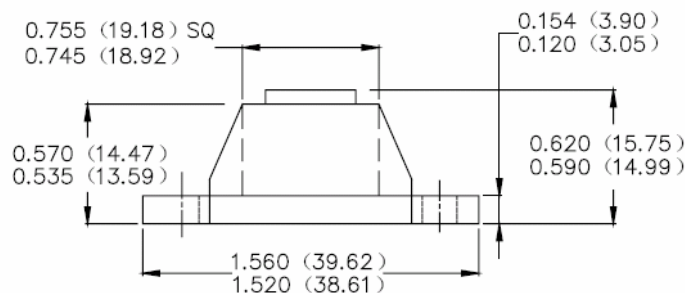
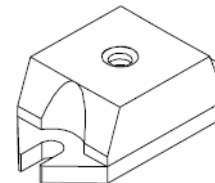
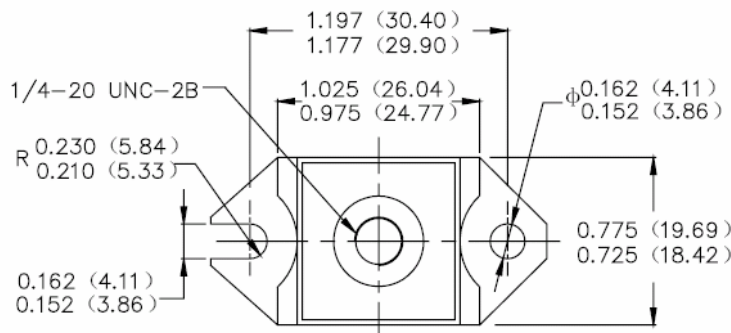

PRM1-1(HALF PAK Module)

MARKING, MOLDING RESIN

Marking for 122NQ030/R-1, 1st row SS YYWWL, 2nd row 122NQ030-1/122NQ030R-1

Where YY is the manufacture year

WW is the manufacture week code

L is the wafer's Lot Number

Molding resin

Epoxy resin UL:94V-0

Maximum Ratings:

Characteristics	Symbol	Condition	Max.	Units
Peak Inverse Voltage	V_{RWM}	-	30	V
Max. Average Forward Current	$I_{F(AV)}$	50% duty cycle @ $T_C=110^{\circ}C$, rectangular wave form	120	A
Max. Peak One Cycle Non-Repetitive Surge Current (per leg)	I_{FSM}	8.3 ms, half Sine pulse	2880	A

Electrical Characteristics:

Characteristics	Symbol	Condition	Max.	Units
Max. Forward Voltage Drop*	V_{F1}	@ 120A, Pulse, $T_J = 25^{\circ}C$ @ 240A, Pulse, $T_J = 25^{\circ}C$	0.49 0.59	V
	V_{F2}	@ 120A, Pulse, $T_J = 125^{\circ}C$ @ 240A, Pulse, $T_J = 125^{\circ}C$	0.41 0.54	V
Max. Reverse Current (per leg) *	I_{R1}	@ $V_R = \text{rated } V_R$ $T_J = 25^{\circ}C$	10	mA
	I_{R2}	@ $V_R = \text{rated } V_R$ $T_J = 125^{\circ}C$	560	mA
Max. Junction Capacitance (per leg)	C_T	@ $V_R = 5V$, $T_C = 25^{\circ}C$ $f_{SIG} = 1MHz$	7400	pF
Typical Series Inductance (per leg)	L_S	Measured lead to lead 5 mm from package body	7.0	nH
Max. Voltage Rate of Change	dv/dt	-	10,000	V/ μs

* Pulse Width < 300 μs , Duty Cycle < 2%

Thermal-Mechanical Specifications:

Characteristics	Symbol	Condition	Specification	Units	
Max. Junction Temperature	T_J	-	-55 to +150	$^{\circ}C$	
Max. Storage Temperature	T_{stg}	-	-55 to +150	$^{\circ}C$	
Maximum Thermal Resistance Junction to Case	$R_{\theta JC}$	DC operation	0.40	$^{\circ}C/W$	
Typical Thermal Resistance, case to Heat Sink	$R_{\theta cs}$	Mounting surface, smooth and greased	0.15	$^{\circ}C/W$	
Mounting Torque	T_M	Non-lubricated threads	Mounting Torque	23(min) 29(max)	Kg-cm
			Terminal Torque	35(min) 46(max)	
Approximate Weight	wt	-	25.6	g	
Case Style	PRM1-1				

Typical Forward Characteristics

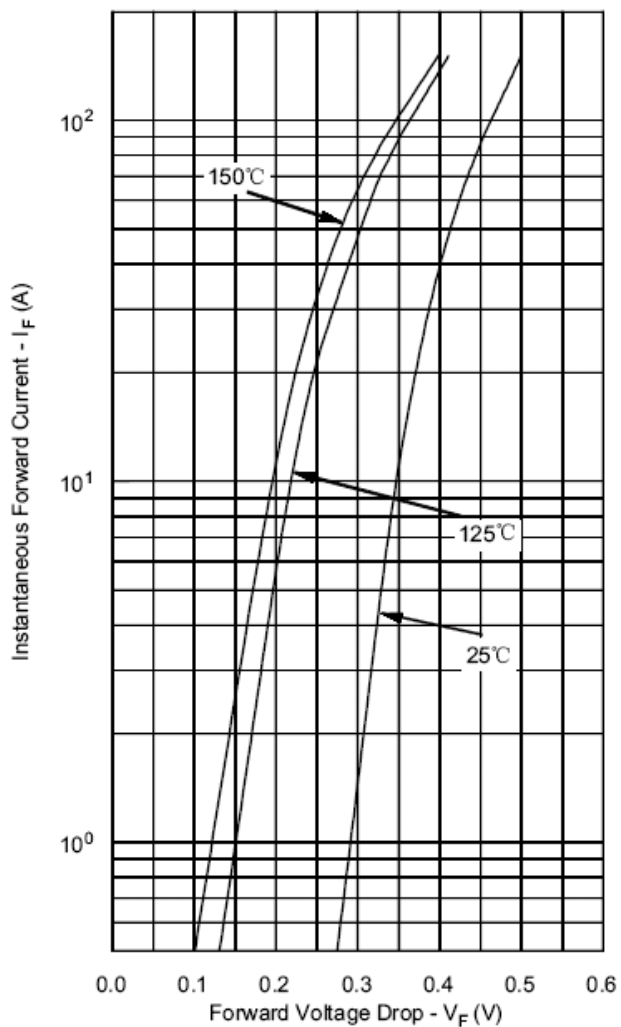

Typical Reverse Characteristics

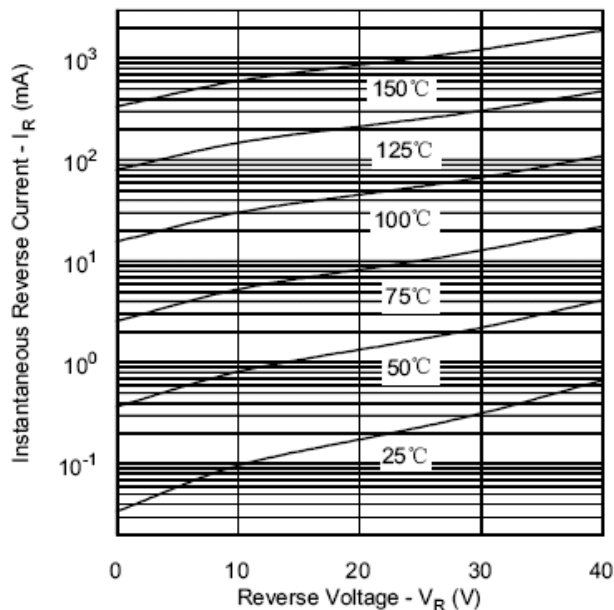

Typical Junction Capacitance

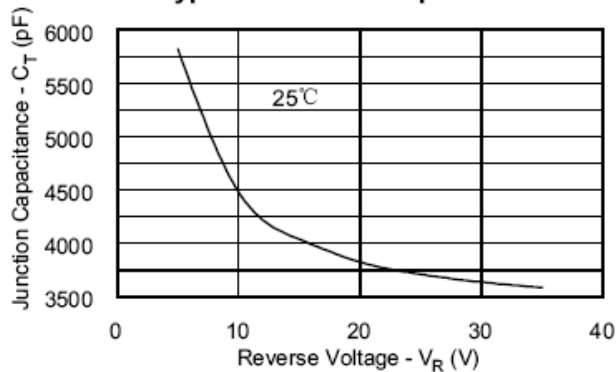

DISCLAIMER:

- 1- The information given herein, including the specifications and dimensions, is subject to change without prior notice to improve product characteristics. Before ordering, purchasers are advised to contact the SMC - Sangdest Microelectronics (Nanjing) Co., Ltd sales department for the latest version of the datasheet(s).
- 2- In cases where extremely high reliability is required (such as use in nuclear power control, aerospace and aviation, traffic equipment, medical equipment, and safety equipment), safety should be ensured by using semiconductor devices that feature assured safety or by means of users' fail-safe precautions or other arrangement.
- 3- In no event shall SMC - Sangdest Microelectronics (Nanjing) Co., Ltd be liable for any damages that may result from an accident or any other cause during operation of the user's units according to the datasheet(s). SMC - Sangdest Microelectronics (Nanjing) Co., Ltd assumes no responsibility for any intellectual property claims or any other problems that may result from applications of information, products or circuits described in the datasheets.
- 4- In no event shall SMC - Sangdest Microelectronics (Nanjing) Co., Ltd be liable for any failure in a semiconductor device or any secondary damage resulting from use at a value exceeding the absolute maximum rating.
- 5- No license is granted by the datasheet(s) under any patents or other rights of any third party or SMC - Sangdest Microelectronics (Nanjing) Co., Ltd.
- 6- The datasheet(s) may not be reproduced or duplicated, in any form, in whole or part, without the expressed written permission of SMC - Sangdest Microelectronics (Nanjing) Co., Ltd.
- 7- The products (technologies) described in the datasheet(s) are not to be provided to any party whose purpose in their application will hinder maintenance of international peace and safety nor are they to be applied to that purpose by their direct purchasers or any third party. When exporting these products (technologies), the necessary procedures are to be taken in accordance with related laws and regulations..